

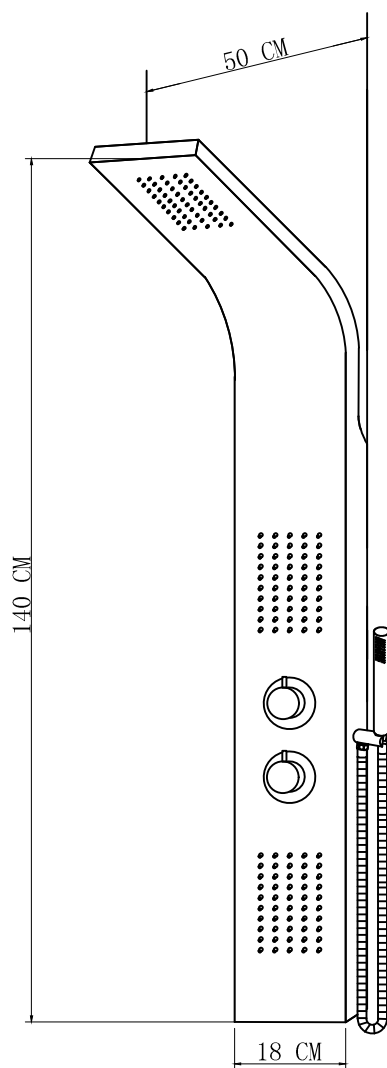









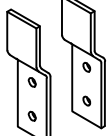

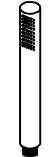
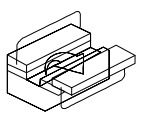
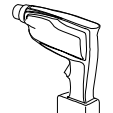

EASY PVC BIANCO

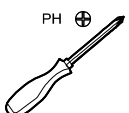

<p>A</p>  <p>X4</p>	<p>B</p>  <p>X4</p>	<p>C</p>  <p>X2</p>	<p>D</p>  <p>X1</p>	<p>E</p>  <p>X4</p>
<p>F</p>  <p>X2</p>	<p>G</p>  <p>X1</p>	<p>H</p>  <p>X1</p>		

			<p>PH ⊕</p> 	<p>Ø6.5</p> 
<p>23#</p> 			 <p>30'</p>	

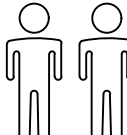
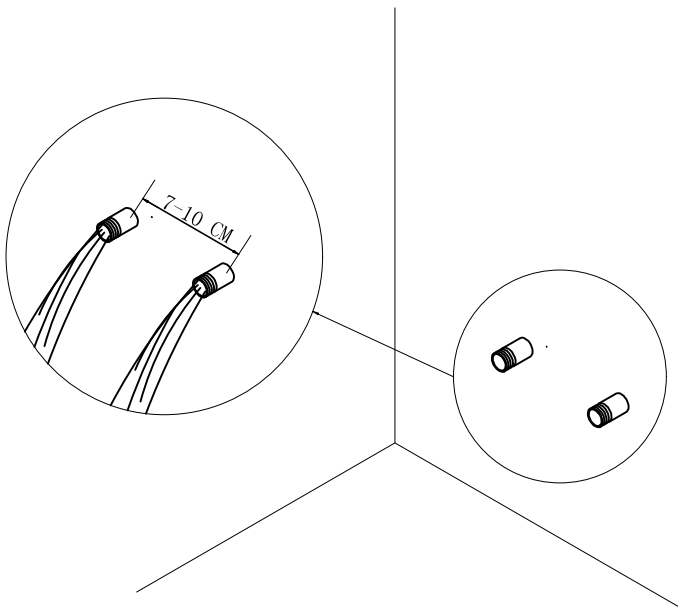

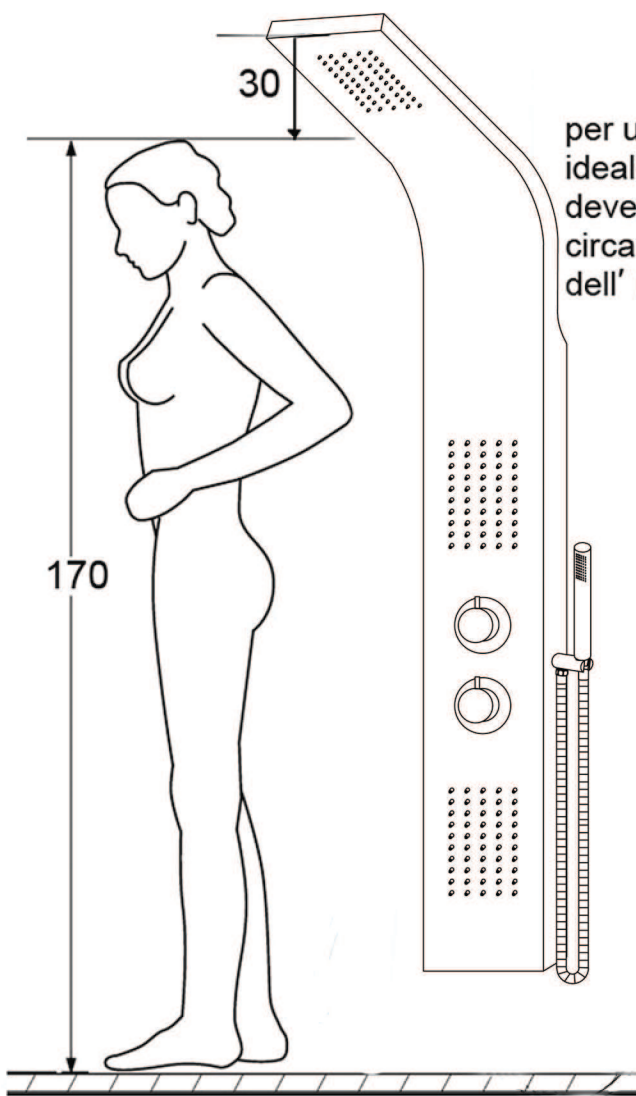

per un posizionamento ideale, il getto superiore deve essere posizionato a circa 30 cm dalla testa dell' utilizzatore.

